

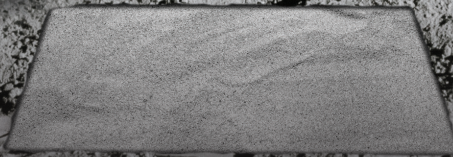

the right support



LUNAR SUPPORT



PEDESTAL LINE

MADE IN ITALY

LUNAR SUPPORT MORE IN ONE SYSTEM

DE 40 A 420 MM CON SOLO 3 ARTÍCULOS
FROM 40 TO 420 MM WITH ONLY 3 ARTICLES

PLOT CON CABEZAL FIJO | FIXED HEAD SUPPORT

LUNAR SUPPORT es la nueva gama de plot con máxima versatilidad, ya que con sólo 3 artículos permite cubrir alturas de 40 a 420 mm.

Su revolucionaria base cuadrada permite ahorrar tiempo de instalación: Ocupa la misma superficie que los plots de la gama Pedestal Line y elimina el problema del corte de la base a lo largo de las paredes. La gama LUNAR SUPPORT engloba todas las características de la línea Pedestal Line: Doble ajuste (lateral y desde arriba), cabezal fijo convertible en autonivelante con la ayuda de un anillo autonivelante, extensiones de 20 y 80 mm para facilitar la colocación en obra y con un almacenamiento óptimo y Sistema EasyOn para una máxima compatibilidad con diferentes superficies.

LUNAR SUPPORT is the new range of highly versatile supports which covers heights from 40 up to 420 mm, with only 3 articles.

Its innovative square base permits to save time during the installation phase; by occupying the same surface area of a round support, it eliminates the problem of cutting the base along the walls. LUNAR SUPPORT range combines all the features of Pedestal Line: double adjustment (from above and lateral), fixed head convertible into self-levelling thanks to a balance ring, 20 mm and 80 mm extensions for easy laying and efficient storage and EasyOn System for maximum compatibility with different surfaces.

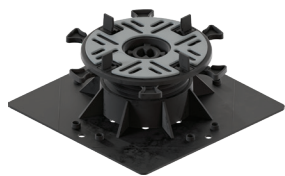

SL401
40÷60 mm

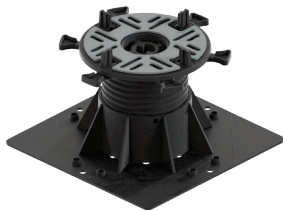

SL402
60÷100 mm



SL403
100÷180 mm

BALDOSAS | TILE & DECKING

Gracias a su exclusivo cabezal EasyOn, la gama LUNAR SUPPORT es compatible con una gran variedad de pavimentos: desde baldosas cerámicas hasta losas de piedra y decking de madera instalados sobre los raíles Impertek.

Thanks to the EasyOn System, the range of LUNAR SUPPORT is compatible with a single head to several floor finishes: from ceramic tiles to stone slabs and decking laid on Impertek joists.



REGULACIÓN DESDE ARRIBA
TOP ADJUSTMENT

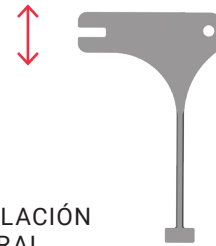

REGULACIÓN LATERAL
LATERAL ADJUSTMENT

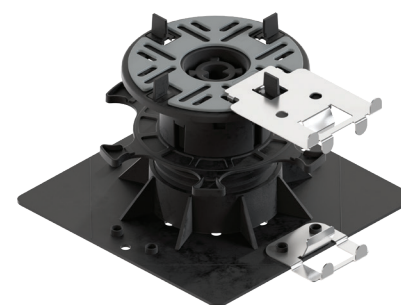

CABEZAL DECKING
DECKING HEAD

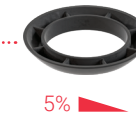

ANILLO AUTONIVELANTE AB-SL
AB-SL BALANCE RING

Instalándolo al cabezal, el anillo permite convertir el plot fijo a autonivelante para una corrección automática de pendientes de hasta el 5% de pendiente.

Attached to the head, the balance ring allows the support to be transformed from fixed to self-levelling, for an automatic slope correction up to 5%.

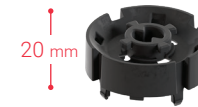

EXTENSIÓN PSL20
PSL20 EXTENSION

Extensión de 20 mm utilizada para reducir el número de artículos en obra. Una vez instalada, la extensión resultará fija y estable. Se pueden apilar un máximo de 3 extensiones.

20 mm extension used to reduce the number of articles on construction site. Once clasped, the extension will result fixed and stable. Up to 3 extensions can be overlapped.



EXTENSIÓN PSL80
PSL80 EXTENSION

Extensión de 80 mm que permite alcanzar hasta 420 mm de altura. Se pueden apilar un máximo 3 extensiones.

80 mm extension which allows the support to reach a maximum height of 420 mm. Up to 3 extensions can be overlapped.

KIT SIDE CLIP PERIMETRAL CSL05 CSL05 PERIMETER SIDE CLIP KIT

Sin cortar la base, los nuevos clips perimetrales se instalan perfectamente al plot, facilitando y agilizando la instalación.

Without cutting the square base, the new perimeter clips clasp perfectly to the support, making the laying much easier and faster.

MADE IN ITALY • IMPERTEK.COM



IMPERTEK Srl

via Po 507 · 30022 · Ceggia · Venezia · Italy
T +39 0421 322 525 r.a · F +39 0421 322 756
info@impertek.com · www.impertek.com